

**Unlocking added value.
Discovering flexibility.
Enabling Industry 4.0.**

 **IO-Link**

Sensors and Systems
with IO-Link



Your automation, our passion.

 **PEPPERL+FUCHS**

Find Your IO-Link Device in Just a Few Clicks

Go online. Specify your requirements. Select your device. You can find the right solution for your application in just a few clicks. If you have any questions, our experts are available to take your call.

Online Search on the Pepperl+Fuchs Website

Enter the model number in the search field on the Pepperl+Fuchs website and get to your product selection immediately. Model numbers can be found in this brochure in the technical data summaries. Or you can navigate through our range of product families and groups. Product selectors help you select the optimal IO-Link device.

For example,
"UC250-F77"

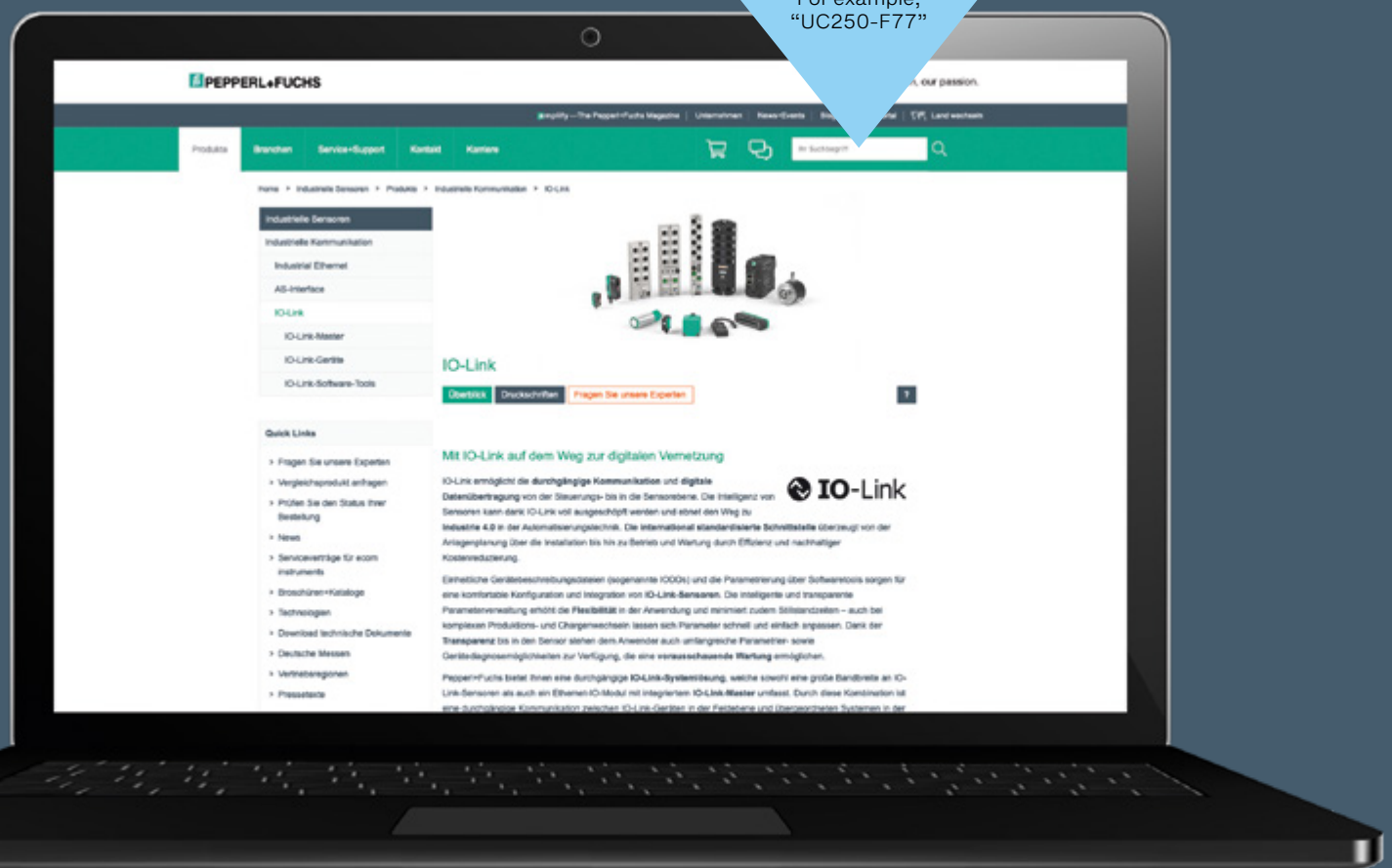

For more information, visit
pepperl-fuchs.com/tf-io-devices

Contents

Technology	4
Portfolio	10
IO-Link Infrastructure	
IO-Link Masters	14
IO-Link USB Masters	18
IO-Link Devices	
Inductive Proximity Sensors	20
Inductive Positioning Systems	22
Photoelectric Sensors	24
Ultrasonic Sensors	26
Rotary Encoders	28
Identification Systems	30
I/O Hub with IO-Link	32
Connectivity	34
Neoeption Digital Services	35

Technology

The Standard for Future-Proof Technology

IO-Link enables comprehensive diagnostics down to the sensor/actuator level, reduces costs, and provides a secure investment. Pepperl+Fuchs' IO-Link portfolio offers a complete solution from a single source for flexible solutions.

Standardization for Industry 4.0

IO-Link is an internationally standardized, cross-vendor IO technology that enables bidirectional communication from the control system to the sensor/actuator level. The fieldbus-independent open standard can be integrated into any system landscape using standard unshielded cables and point-to-point connectivity. Bidirectional communication enables comprehensive diagnostics and data transfer is interference-free.

Complete Solution from a Single Source

Pepperl+Fuchs' IO-Link portfolio allows users to choose from a wide range of sensor technologies, including photoelectric sensors, ultrasonic sensors, inductive proximity sensors, positioning systems, and RFID. In addition to IO-Link sensors, I/O hubs with IO-Link offer another economical solution for connecting standard digital sensors. The complete solution is rounded off by IO-Link masters, connectivity, and software.

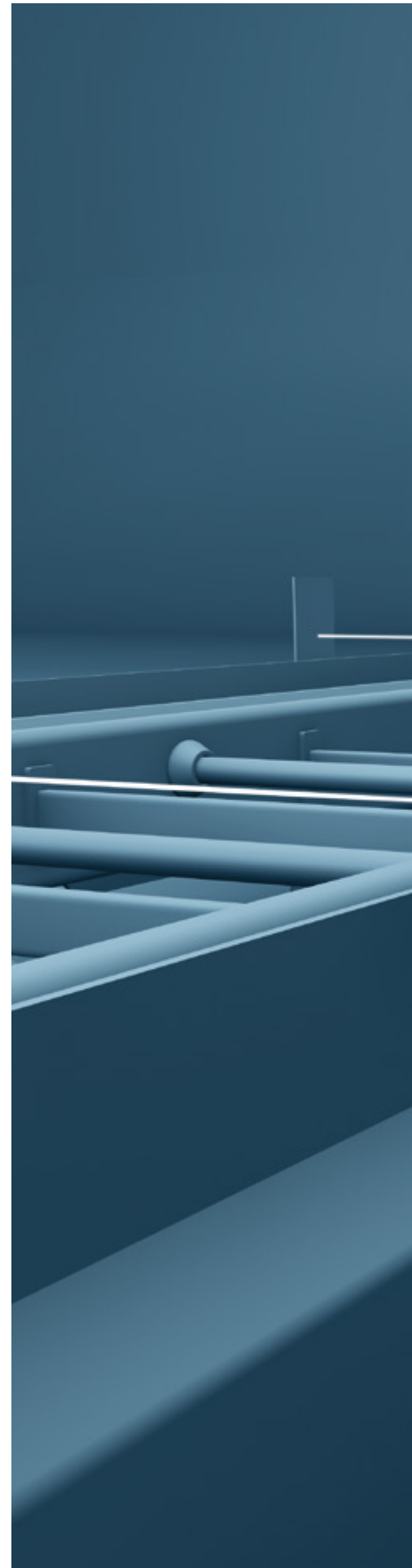

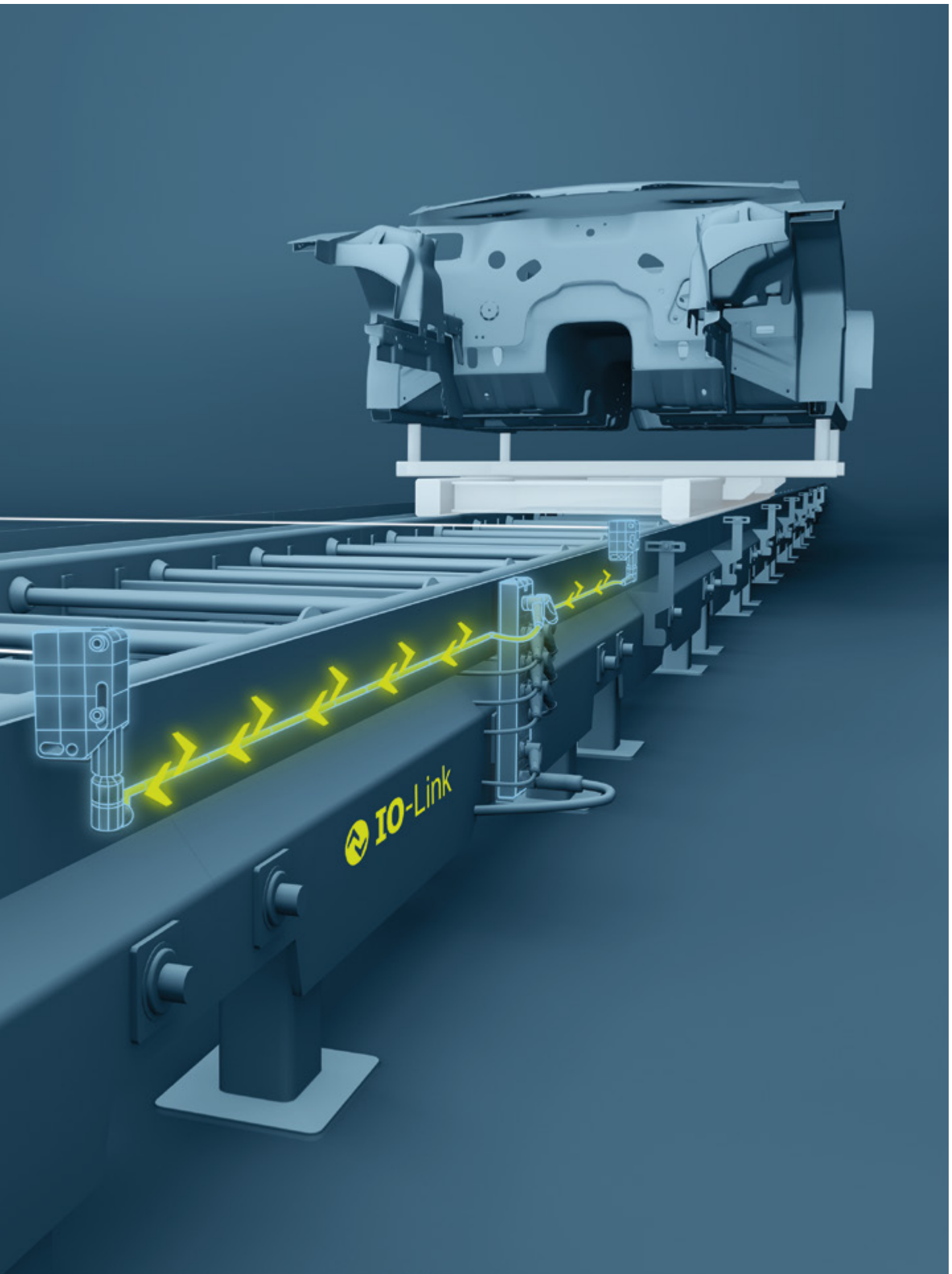

Reducing Costs with IO-Link

IO-Link offers countless new possibilities and creates added value for users. It reduces complexity, provides needs-based maintenance with comprehensive diagnostics, and enables individualized production with central data storage and automatic configuration.

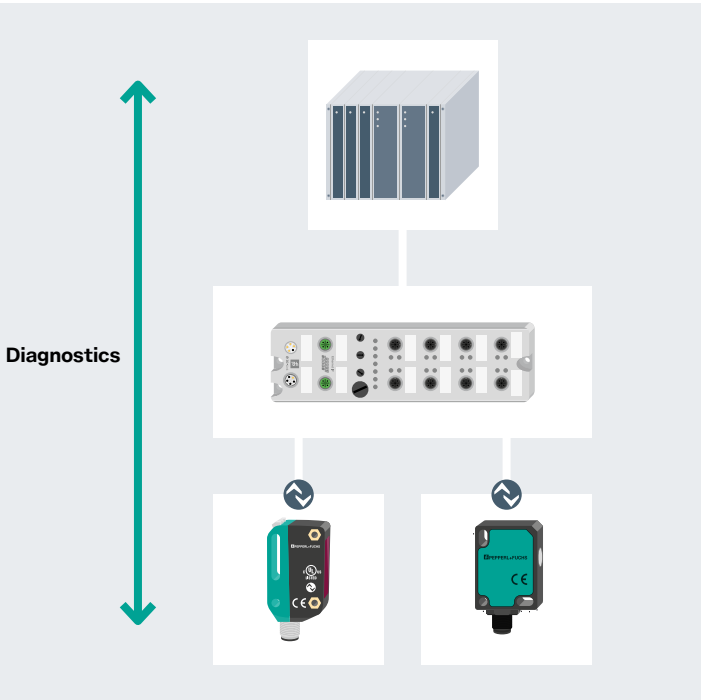

Acyclical data for comprehensive diagnostics

Comprehensive Diagnostics Down to the Sensor/Actuator Level

Bidirectional communication from the control system to the field level enables comprehensive diagnostics of sensors and actuators. In addition to cyclical process data, a wealth of additional data is transferred acyclically, allowing device identification to be performed at any time. The control system simply accesses the manufacturer, part number, and serial number information saved in every IO-Link device. Diagnostic information about the general device condition, specific data from operation, temperature, and signal quality are also available.

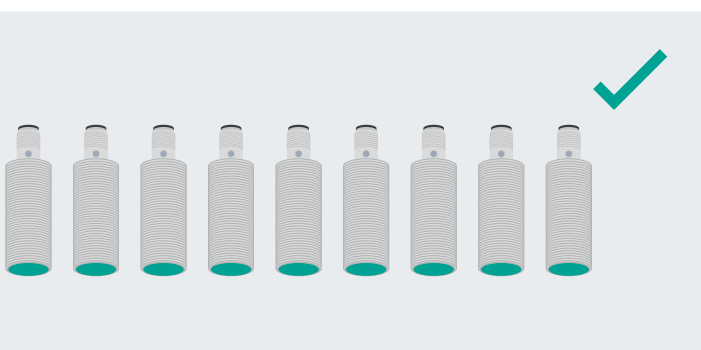
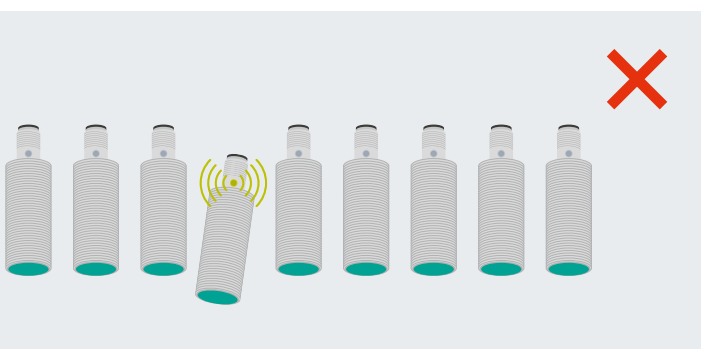

Sensor and target misalignment can be identified early via stability alarm

Easy and Efficient Maintenance

With diagnostic data from the IO-Link device, maintenance can be scheduled and carried out based on the needs of plants and machines.

If an inductive proximity sensor with IO-Link falls out of alignment and the target is no longer in range, a stability alarm can be triggered. During the next maintenance cycle, the sensor can be readjusted by maintenance personnel.

If a sensor needs to be replaced, simply replace it with a new one and let IO-Link import the existing settings. This avoids downtime and unnecessary costs.

Batch Size 1 Production

IO-Link sensors can be configured via the control system. This simplifies commissioning and makes quick recipe changes possible without extended downtime. Even complete individualization—batch size 1 production—is possible.

For example, the beam width on an ultrasonic sensor can be adjusted to accommodate different container shapes in a level-measurement application.

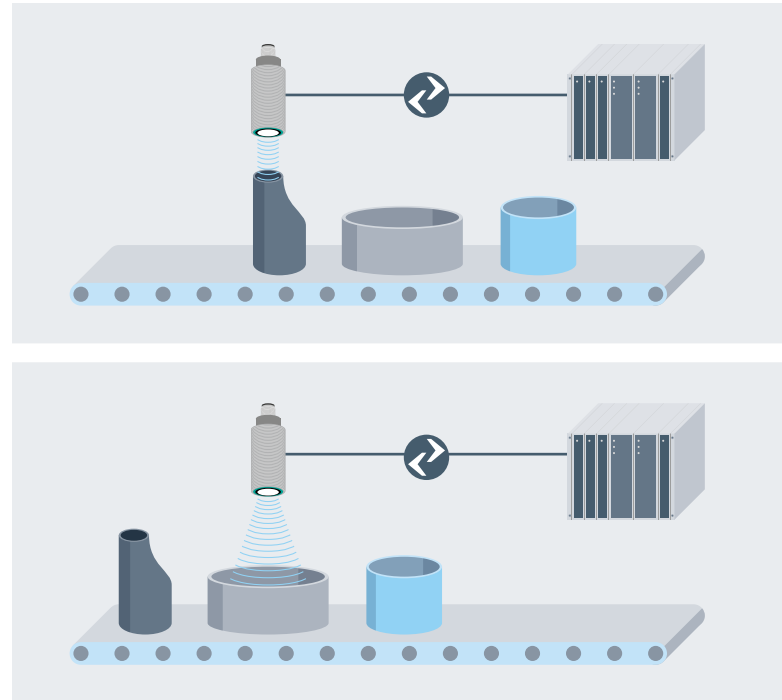

Automatic beam width adjustment on an ultrasonic sensor

IO-Link at a Glance

- Bidirectional, serial point-to-point connectivity for signal and power
- Operating modes: Standard IO mode (SIO), IO-Link mode
- Three transfer rates: 4.8 kBaud (COM 1), 38.4 kBaud (COM 2), 230.4 Kbaud (COM 3)
- Unshielded standard industry cable for all connections
- Pin assignment: Pin 1: 24 V, Pin 3: 0, Pin 4: Switching and communication line (C/Q)
- Cable length: 20 m maximum

 **IO-Link**

For more information, visit
[pepperl-fuchs.com/tf-io-link](https://www.pepperl-fuchs.com/tf-io-link)



Future-Proof with IO-Link

Smart Sensor Profiles for simple integration and a reliable investment—Pepperl+Fuchs is pioneering integration of the new standard and paving the way toward Industry 4.0.

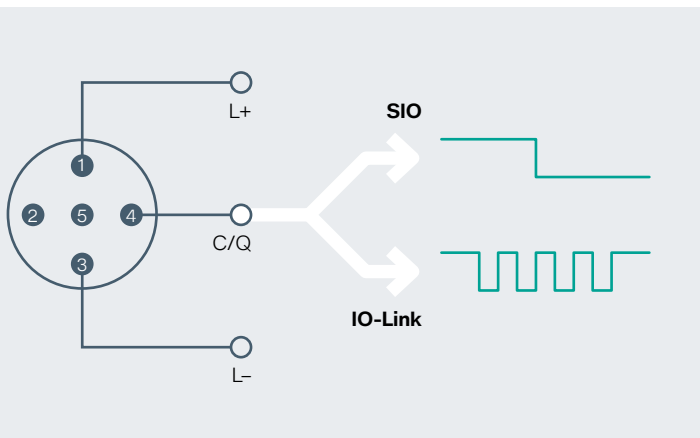

Standardized pin assignment of IO-Link devices

Uniform Structures Ensure Efficiency

Every IO-Link device that incorporates Smart Sensor Profiles is developed to follow a general specification and structure. The same device information is always stored and available anytime, and the pin layout and available operating modes are also identical in every device. This standardization ensures efficient machine design—and compatibility with Industry 4.0.

Sensorik

4.0

Sensorik4.0®—Paving the Way for the Smart Factory

IO-Link sensors pave the way for the Fourth Industrial Revolution. In the Industry 4.0 future of fully networked production systems, communication-ready sensors play a vital role: they send and receive sensor data within production processes and to higher-level local or cloud-based information systems.

To pave the way for Industry 4.0, Pepperl+Fuchs is providing innovative sensor technologies with Sensorik4.0®. They use the standard IO-Link interface to support the digitization of industrial applications.

Smart Sensor Profiles: Finding a Common Denominator

To achieve true standardization, data transfer, data structures, and data content must be clearly defined for all manufacturers. Smart Sensor Profiles have been developed for this purpose. They divide all sensors into types that are not determined by manufacturer or sensing mode but by the signal that a sensor transmits.

Profile-specific function blocks exist for each profile class to make integration quick and easy for users. Once a device from a specific profile class is initially integrated into a control system, the integration of additional devices from the same profile is simple.

This makes it possible to quickly replace a photoelectric distance sensor with a sensor from another manufacturer or with a measurement sensor that uses another sensing technology, such as an ultrasonic sensor.

Pepperl+Fuchs is pioneering the integration of Smart Sensor Profiles in current and future product development projects, paving the way for international standardization and Industry 4.0.

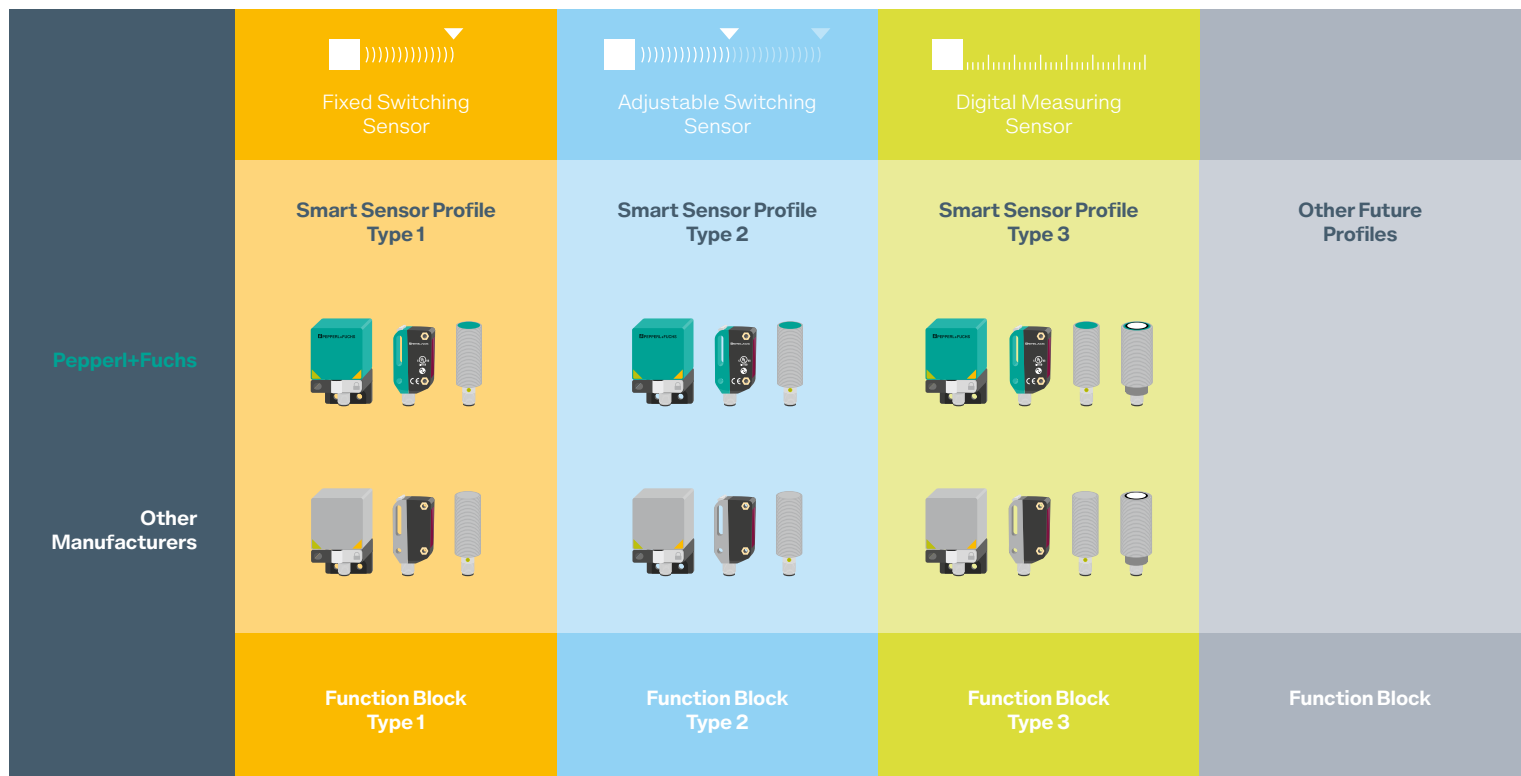

Complete Solution from a Single Source

A comprehensive portfolio of IO-Link devices, IO-Link infrastructure, software, and connectivity—this is the complete solution of intelligent IO-Link systems from Pepperl+Fuchs.

Flexible Applications

Pepperl+Fuchs' IO-Link portfolio offers flexible solutions for a range of applications—photoelectric sensors, ultrasonic sensors, rotary encoders, inductive proximity sensors, positioning systems, and RFID. In addition to sensors, IO-Link masters, connectivity, I/O hubs, and software are also available.

IO-Link Devices: Broad Portfolio for Any Requirement

Every application poses unique challenges. Pepperl+Fuchs' broad product portfolio includes a range of sensing technologies and housing styles that can be seamlessly integrated into all applications.

IO-Link Infrastructure: Optimized for Every Application

Take full advantage of IO-Link. Pepperl+Fuchs offers a range of IO-Link infrastructure: an IO-Link USB master for offline configuration, various IO-Link masters for connection to higher-level fieldbuses as well as IO-Link masters with OPC UA for applications even without classic control. The portfolio is completed by matching software and perfectly coordinated connectivity.



For an overview of the IO-Link portfolio, visit pepperl-fuchs.com/tf-io-portfolio



PLC control

IO-Link Infrastructure



IO-Link USB master

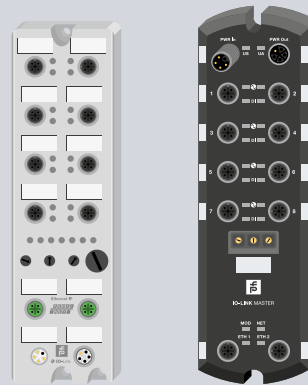

IO-Link master

IO-Link Devices



Inductive proximity sensors



Inductive positioning systems



Photoelectric sensors



Ultrasonic sensors



Rotary encoders



Identification systems

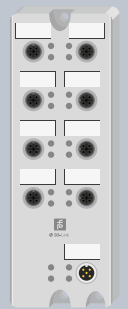

I/O hub with IO-Link

Standard Devices

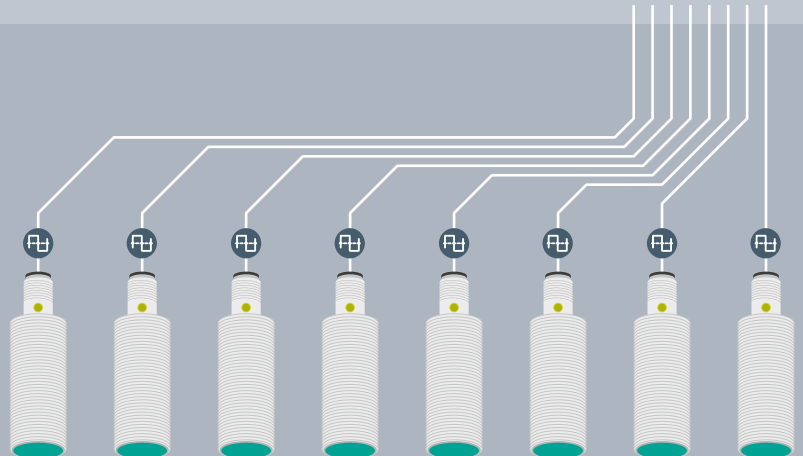

Digital sensors

Software Tools for Every Application

Pepperl+Fuchs offers a comprehensive set of tools for sensor configuration and diagnostics. Convenient, standardized user interfaces make sensors even easier to use.

IODD: Standardized Device Description for Easy Commissioning

Every IO-Link device has an IO device description (IODD) file that contains a range of information for integration into different systems. This information includes communication characteristics, available parameters and functions, and the user interface, among other things.

Because the IODD structure has been standardized for all devices, it can always be read the same way—regardless of the IO-Link master being used, the manufacturer, or the automation system.

The Right Software for Every Need

In addition to the IODD, several software tools are available for configuring IO-Link devices. From device DTMs for configuring a device via PACTware to function blocks for user programs in the control system, Pepperl+Fuchs offers software for every situation.



For more information, visit
pepperl-fuchs.com/tf-io-link

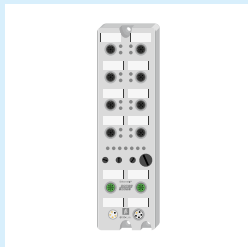
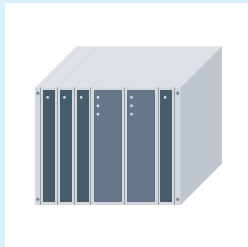
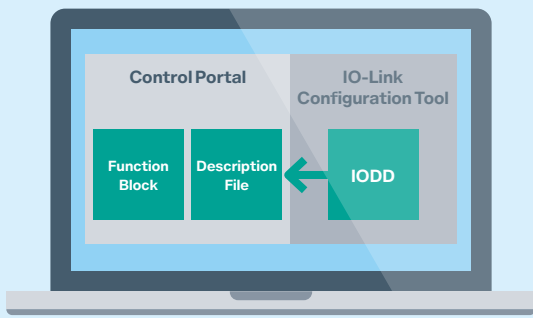

Online Configuration

To commission machines and plants, the IO-Link master and devices must be integrated into the appropriate automation system, which requires different software.

Then, the IO-Link configuration tool can be used to configure devices. During operation, IO-Link device parameters can be set, and diagnostic data can be monitored. The integration of IO-Link data into an application program takes place via function blocks.

Offline Configuration

With offline configuration, IO-Link devices are configured before they are mounted. Pepperl+Fuchs' IO-Link USB master can be used for this.

In addition to the master, a program such as PACTware, USB Master DTM, or IODD interpreter is required to display an IO-Link device's IODD.

Device DTMs simplify operation of more complex devices with a graphical interface.

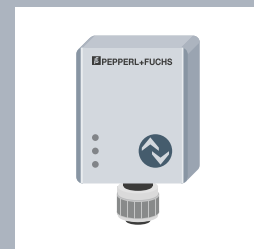
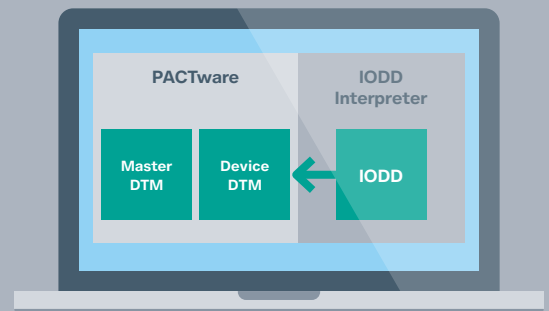

Efficient, Innovative, and Durable

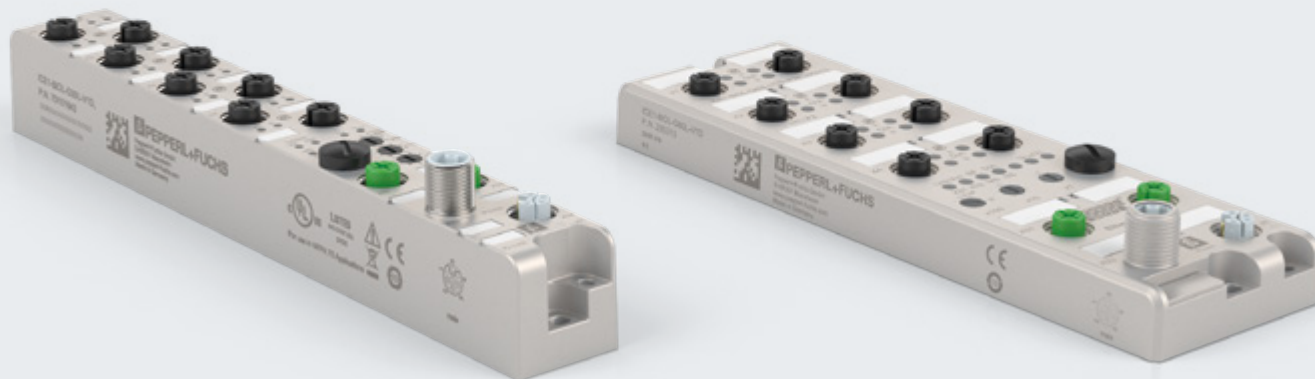

Enabling Process Reliability and Standardization

Designed for traditional PLC-based applications, the ICE1* modules offer greater process reliability. The integrated web server can be activated or deactivated as needed. This means the module is only accessible via the PLC—external access is blocked. With a multiprotocol capability, the IO-Link masters offer a great deal of efficiency for standardizing machines and plants. The innovative, high-performance connection technology optimizes installation.

Highlights

- All standard Ethernet communication protocols are supported in one single module for optimal machine standardization
- Innovative M12 power connector for reduced installation costs thanks to higher current capability of 2x 16 A for sensors and actuators
- Integrated IO-Link master for continuous diagnostics and parameterization from the control system to the sensor level

Technical data	ICE1-8IOL-G60L-V1D	ICE1-8IOL-G30L-V1D
Inputs/outputs	8-port IO-Link master	
Housing	Die-cast zinc—nickel-plated surface	
Rated current	2x 16 A	
Operating temperature	-20 °C ... +70 °C	
Degree of protection	IP69	
Dimensions	200 x 59.6 x 30.7 mm	225 x 30 x 43 mm

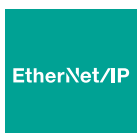

Selected products from the portfolio.
For more IO-Link masters, visit
pepperl-fuchs.com/tf-io-master



Rugged Design, Extreme Durability

The rugged design of these modules ensures durability in harsh, industrial environments. The fully encapsulated metal housing is extremely resistant to mechanical damage and environmental factors. It is dust-tight and withstands water during high-pressure/steam jet cleaning in accordance with IP69 standards. The modules also operate in a wide range of temperatures, from $-20\text{ }^{\circ}\text{C}$ to $+70\text{ }^{\circ}\text{C}$, and they are resistant to mechanical vibration (15 g) and shock (50 g).

Optimized for PLC-Based Applications

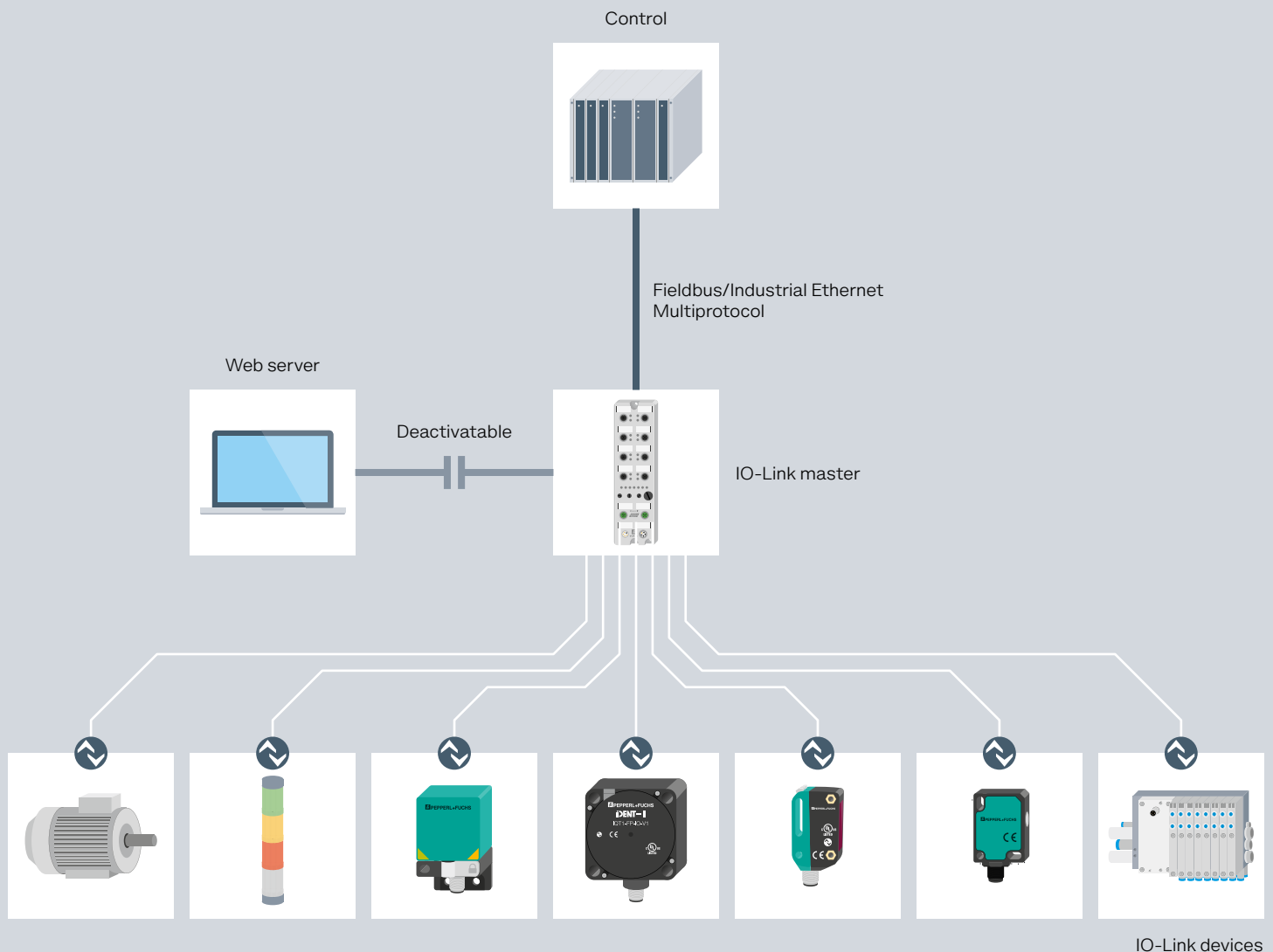

From the Sensor to the Cloud



Flexibility for the Future

IoT-optimized ICE2* and ICE3* modules offer everything that flexible cloud applications need. With MultiLink™, multiple sources can access the device in parallel and make the right data available wherever it is needed. Whether with a traditional PLC and an industrial PC or as a purely cloud-based application, IO-Link masters from Pepperl+Fuchs offer the most flexibility and planning reliability.

Highlights

- OPC UA interface for cloud-based applications that pave the way for future Industry 4.0 scenarios
- MultiLink—simultaneous communication with PLCs and cloud/SCADA systems offers outstanding flexibility in automation systems
- Integrated web server and IODD interpreter enable simple configuration via a web browser
- PortVision® DX software offers network configuration, device management, and settings cloning/backup in one application

Technical data	ICE2-8IOL-G65L-V1D ICE3-8IOL-G65L-V1D	ICE2-8IOL-K45S-RJ45 ICE3-8IOL-K45S-RJ45
Inputs/outputs	8-port IO-Link master	8-port IO-Link master
Housing	Polyamide (encapsulated)	Polyamide
Rated current	16 A	3.7 A
Operating temperature	-25 °C ... +60 °C	-40 °C ... +70 °C
Degree of protection	IP67	IP20
Dimensions	212 x 65 x 30 mm	118 x 45 x 114 mm



Selected products from the portfolio.
For more IO-Link masters, visit
pepperl-fuchs.com/tf-io-master



Optimized for IoT Applications

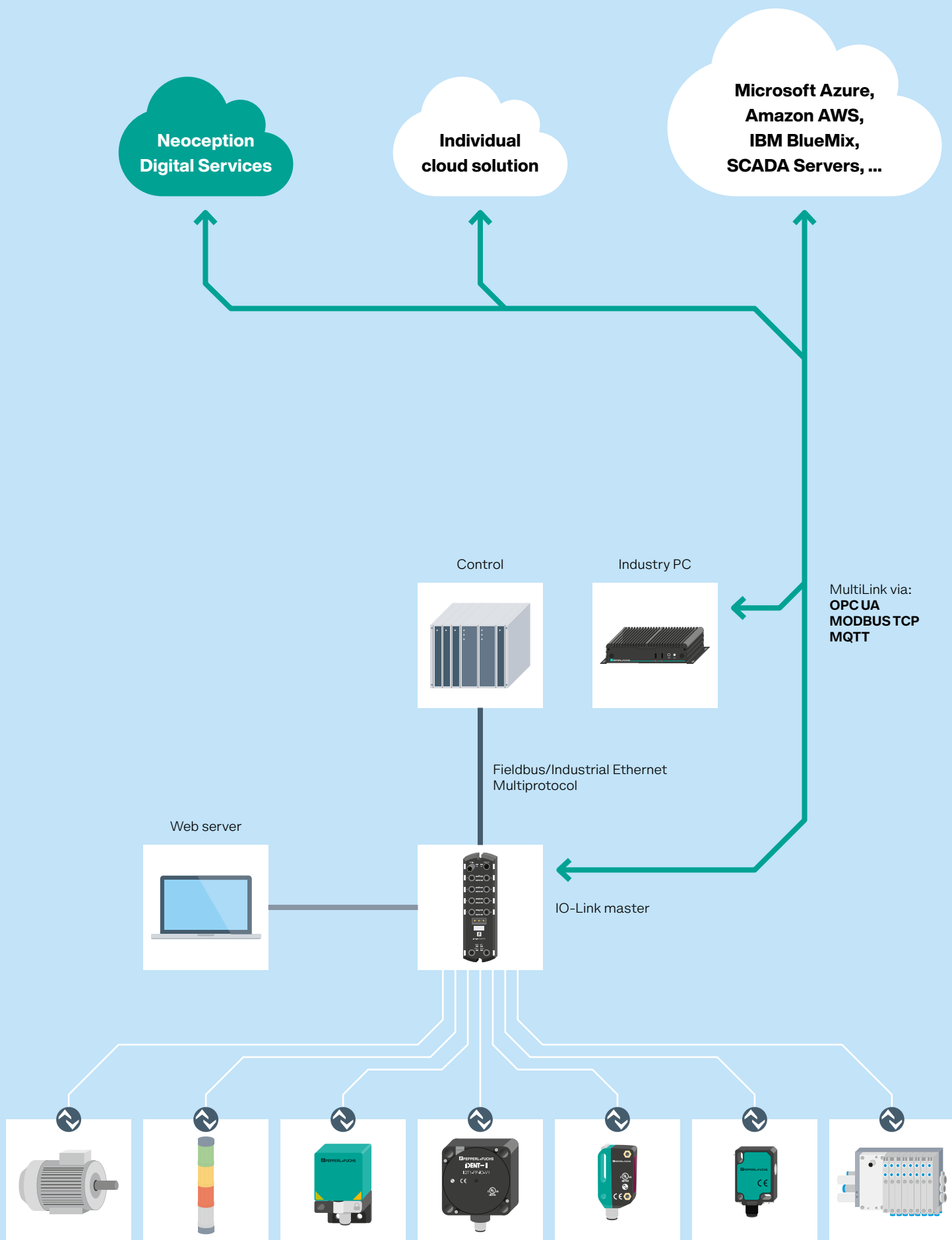

IO-Link devices

Offline Configuration—Easy and Universal



Flexible Configuration for All IO-Link Devices

Get an IO-Link sensor up and running quickly and easily—and do it all from your desk. The IO-Link USB master acts as a link between a standard office infrastructure with Windows® PCs and an industrial IO-Link device.

The computer's USB port is used for both communication and power, allowing sensors to operate immediately without complex wiring. For devices with higher current consumption, an additional power supply is included with delivery.

Highlights

- Offline operation for a variety of applications via standardized interfaces and tools
- Plug-and-play with power supply from the USB port
- Standard M12 connector for quick connectivity with conventional cables

Technical Data

IO-Link-Master02-USB

Dimensions	70 x 41 x 24 mm (L x W x H)
Mass	100 g
Connection	IO-Link port: 1x M12, 5-pin, A-coded Operating voltage: DC-9, 2.1 mm USB 2.0: USB connector type MiniB
Interfaces	IO-Link, USB
Functional principle	Master mode
Standards	IEC 61131-9 (IO-Link Version 1.0 and 1.1)
Power supply	24 V DC/USB 5 V DC



For more information, visit
www.pepperl-fuchs.com/tf-io-master

Small but Mighty

The IO-Link USB master enables any IO-Link device to be preconfigured and tested via the IODD interpreter included in the software package from Pepperl+Fuchs.

Read parameter data from an IO-Link device, record changes and save data externally, duplicate and compare device settings—these are only a few of many possibilities. Previous knowledge of control system programming is not necessary.

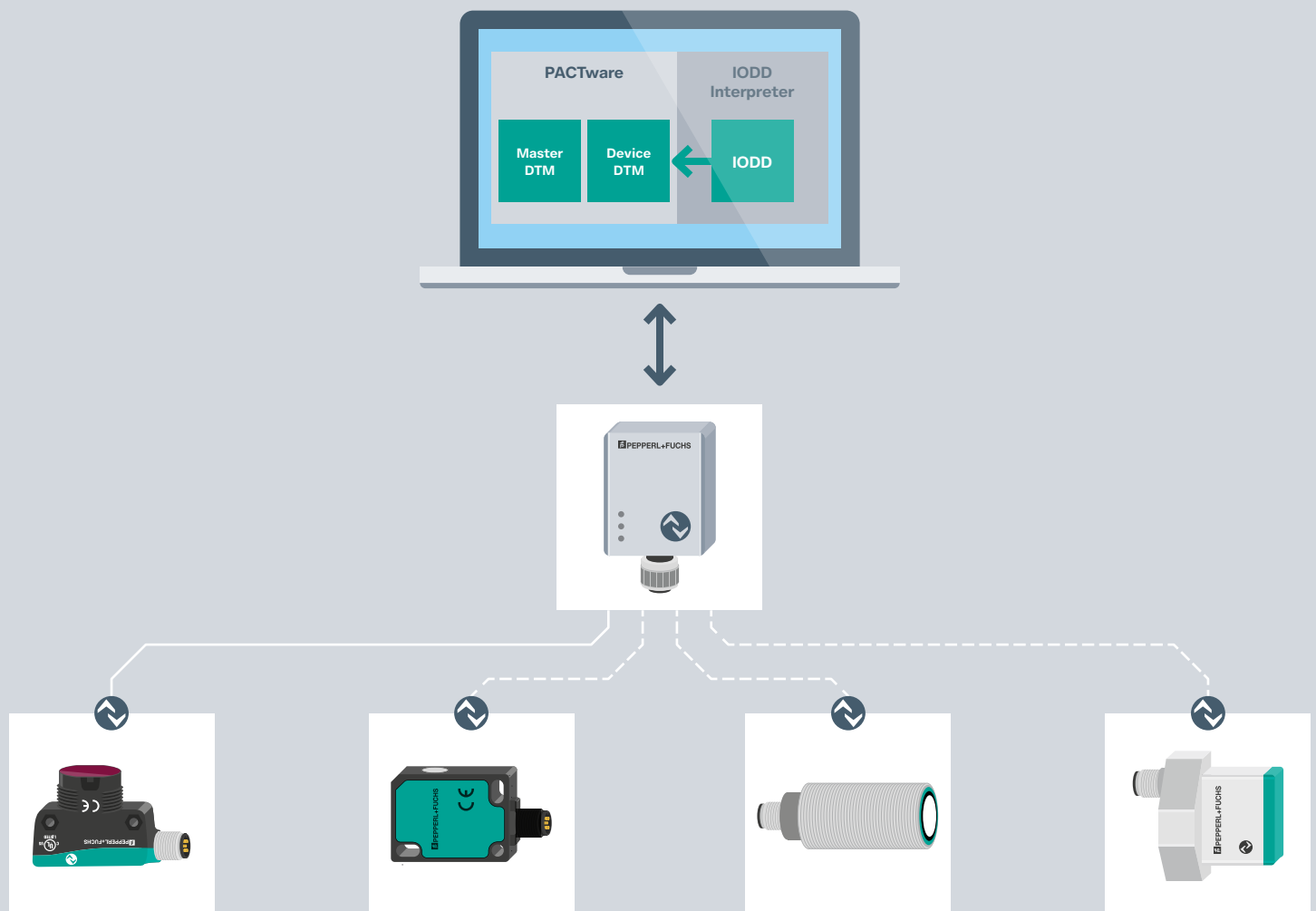

IO-Link USB master for offline parameterization before assembly

Identical Switching for All Metals

Adaptability—Even in Applications with Multiple Target Types

Starting with steel, the switching distances of conventional inductive sensors are reduced, metal to metal, by a defined reduction factor. This is not the case with reduction factor 1 sensors, which offer identical switching distances for all metals with a single sensor. This allows much more flexibility in machine design and use in applications with multiple target metals. By using only one sensor instead of several, procurement, storage, and administration costs are reduced. In addition, reduction factor 1 sensors offer high magnetic field immunity for use in weld cell environments.

Highlights

- Flexible—a broad portfolio of sensors with identical switching distance, regardless of a target's material
- Smart maintenance via stability alarm and temperature indicator
- Rugged, weld-immune sensors with IP68/IP69K protection for harsh industrial environments



IO-Link 1.1

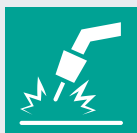

Weld-immune versions available

Selected products from the portfolio.
For more proximity sensors, visit
[pepperl-fuchs.com/tf-io-inductive](https://www.pepperl-fuchs.com/tf-io-inductive)



Technical Data	M12	M18	M30	Varikont L
IO-Link standard	NR*-12GS40-E2-IO-*-V1	NR*-18GS40-E2-IO-*-V1	NR*-30GS50-E2-IO-*-V1	NR*-L3-E2-IO-*-V1
IO-Link weld-immune	NR*-12GS40-E2-IO-C-V1	NR*-18GS40-E2-IO-C-V1	NR*-30GS50-E2-IO-C-V1	NR*-L3-E2-IO-C-V1
Switching distance				
Flush	4 mm	8 mm	15 mm	20 mm
Non-flush	10 mm	15 mm	30 mm	40 mm
Output	3-wire, PNP, NO/NC programmable			
Housing	Threaded sleeve M12 x 1	Threaded sleeve M18 x 1	Threaded sleeve M30 x 1.5	40 x 40 x 40 mm (Varikont L) 40 x 40 x 120 mm (Varikont)

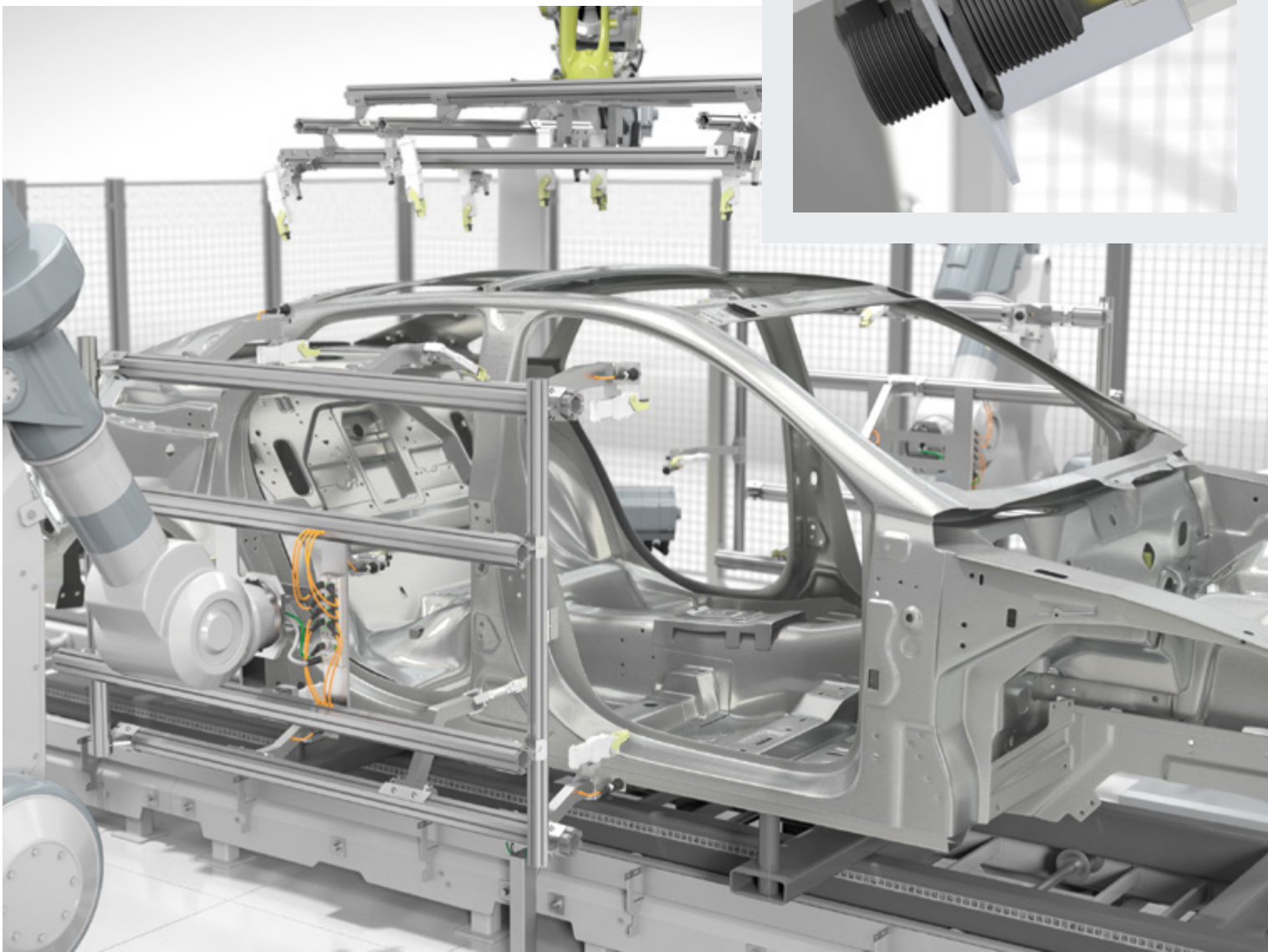
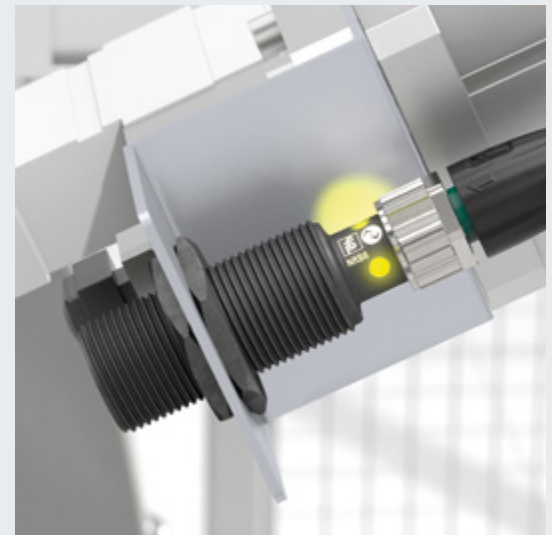

Patented Technology for Precise Position Detection

Maximum Precision and Efficiency

A patented configuration and wiring of multiple coils within a single sensor and intelligent evaluation enable maximum precision and efficiency. This allows simple steel actuators to be used. Whether the actuator is the customer's design, from Pepperl+Fuchs' accessory portfolio, or part of the machine module being monitored—PMI inductive positioning systems always detect the exact position.

F112 Series

With a measurement length of 14 mm, the F112 series provides high-precision position data or switch points/windows. Fully encapsulated in a rugged metal housing with IP67 protection, the sensor withstands tough conditions and, with IO-Link, offers new possibilities in space-restricted applications.

F90 Series

IO-Link, simultaneous detection of two damping elements, as well as measuring and switching functions in one device—the F90 series offers an unprecedented range of features for your application. Available in three measurement lengths (40 mm, 80 mm, and 120 mm), the best solution is always available. Certified versions are also available for applications in ATEX Zone 2/22 (3G nA, 3D tc) hazardous locations.

Highlights

- Maximum durability with noncontact, maintenance-free technology and high environmental protection
- Simple steel actuator opens up a variety of possible applications
- Flexibility due to a wide range of functions and programmable measuring and switching range



IO-Link 1.1



Zone 2/22
(3G nA, 3D tc)



Measuring and switching
in one device

Selected products from the portfolio.
For more identification systems, visit
pepperl-fuchs.com/tf-io-positioning



Technical Data	PMI*F90-IU-IO	PMI*F90-3EP-IO	PMI*F90-IU2EP-IO-V15	PMI*F112-U-IO	PMI*F112-2EP-IO	PMI*F112-2EPE2-IO
Measurement length	40, 80, 120 mm	40, 80, 120 mm	40, 80, 120 mm	14 mm	14 mm	14 mm
Output type	1 analog output (current or voltage)	3 switching outputs (push-pull)	1 analog output 2 switching outputs (push-pull)	1 analog output (voltage)	2 switching outputs (push-pull)	2 switching outputs (push-pull) 1 switching output (PNP)

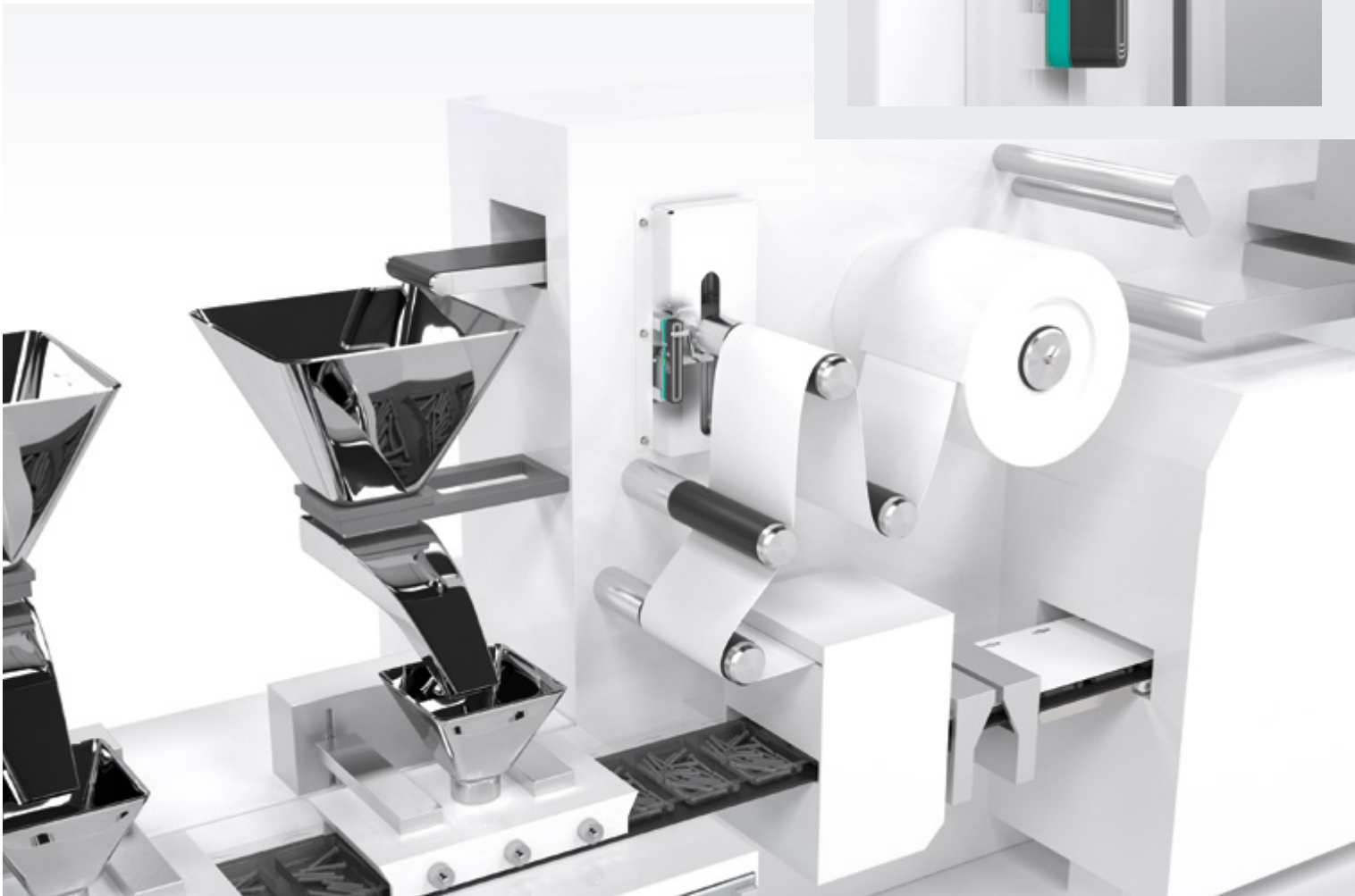

Standard Housings—All Sensing Modes

Forward-Thinking Product Design— Endless Application Possibilities

A complete family of sensing modes in five standard housing styles with one user interface and IO-Link in every model. The forward-thinking design of Pepperl+Fuchs' R100, R101, R103, R200, and R201 series simplifies installation and reduces costs.

Highlights

- All photoelectric sensing modes in standard housing styles for maximum flexibility and more integration possibilities
- Simple installation and setup with one user interface for all housing styles and sensing modes
- IO-Link and Smart Sensor Profile in every sensor: standardized communication down to the sensor level as the basis for Sensorik4.0®
- Precise and reliable MPT distance measurement in a standard small housing



IO-Link 1.1



Up to IP69K



Smart Sensor
Profile

Selected products from the portfolio.
For more photoelectric sensors, visit
pepperl-fuchs.com/tf-io-opto



Smart Sensor Profile: Pioneering the Standardization of IO-Link

Pepperl+Fuchs is among the first manufacturers to implement Edition 2 of the Smart Sensor Profile—including in the R200 and R201 series. This standard will also be implemented in future Pepperl+Fuchs products, and additional Smart Sensor Profiles with new function classes will be integrated into future developments.

Sensing Mode	Red Light LED (Power-Beam)	DuraBeam Laser	Infrared LED (R100, 101)
Thru-beam sensor	■	■	■
Retroreflective sensor with polarization filter	■	■	
Retroreflective sensor without polarization filter			■
Retroreflective sensor with clear object detection	■		
Diffuse mode sensor	■		■
Diffuse mode sensor with background suppression	■	■	■
Diffuse mode sensor with background evaluation	■	■	■
Measuring sensor with multiple switch points	■	■	■
Distance sensor	■	■	



Extreme Performance in Reduced Space

Impressive Functionality

With IO-Link, sound beam adjustment, synchronization, long detection ranges of up to 800 mm, and minimal dead bands, F77 series ultrasonic sensors offer an unparalleled range of features and adjustment options. The series is available in a standard or side-looker version with integrated M18 thread. The minimized dead bands and long detection range mean objects close to the sensor and farther away are detected reliably. The sound beam width is easy to switch depending on requirements.

Highlights

- Highly adaptable: a single sensor can be adjusted to fit a wide range of applications
- Precise and reliable: high noise immunity and multiplex capability for maximum reliability
- Simple integration: compact, space-saving housing design with thru-hole and surface-mount options



IO-Link 1.1

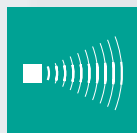

Adjustable
sound beam

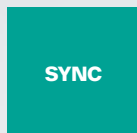

Synchronization

Selected products from the portfolio.

For more ultrasonic sensors, visit
pepperl-fuchs.com/tf-io-ultra



Simple Configuration for Batch Size 1 Production

With IO-Link, UC-F77 series sensors can be adapted to the demands of the application. Filter settings, sound beam width, switch points, and other parameters can be easily adjusted via the control system—even during production. This enables quick automatic recipe changes and individualized production down to batch size 1.

Technical Data	UC250-F77	UC400-F77	UC800-F77S
Sensing mode	Diffuse	Diffuse	Diffuse
Sensing range	20 ... 250 mm	30 ... 400 mm	60 ... 800 mm
Operating voltage	10 ... 30 V DC (18 ... 30 V DC analog output versions)		
Output type	1 switching output (push-pull output) 1 analog output (current or voltage)		



Simplified Condition Monitoring for Increased Plant Availability

Flexible and Cost-Effective

The IO-Link encoder from Pepperl+Fuchs offers a wide range of mechanical interfaces and settings. Multiple software configuration options are available, which means a single device can be used to solve a wide variety of applications. This maximizes flexibility and warehouse efficiency.

The Pepperl+Fuchs IO-Link encoder has a total resolution of 31 bit and a transfer rate of 230.4 kBit/s (COM3). Its measured

values provide information on absolute position (single and multiturn) and direction of rotation. The IO-Link encoder also delivers information about current ambient temperature and critical machine states. This provides status information on (cyclical) process data and enables a quick response if critical changes are needed. The configuration allows the output data to be easily interpreted—for easy monitoring and better plant performance.



IO-Link 1.1

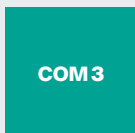

Selected products from the portfolio.

For more encoders, visit:

pepperl-fuchs.com/tf-io-encoder



Highlights

- System reliability feedback from intelligent diagnostic functions
- Condition monitoring with critical detection warnings
- Flexible, configurable rotary encoder enables standardized machine design
- Variety of shaft and flange configuration options available
- Optionally also available with preset parameters

Excerpt of technical data

ENA**TL - IO-Link

Accuracy	0.1°
Resolution	16 bit (single turn), 15 bit (multiturn)
Direction of rotation	Clockwise or counterclockwise
Shaft type	Solid or recess hollow
Flange	Servo, clamping, or spring-plate mounting
Housing dimensions	36 mm, 58 mm
Degree of protection	IP65, IP67



RFID Read/Write Heads— Industry 4.0 Identification with IO-Link

Flexible Identification Solution Simplifies Integration

RFID read/write heads with IO-Link offer simplicity and flexibility. With autostart functionality, they simplify integration dramatically. Combining our Ethernet IO module with IO-Link master with the new RFID read/write heads, Pepperl+Fuchs offers a complete, flexible identification solution.

RFID IO-Link read/write heads operate in the HF range according to ISO 15693 and offer a read/write range of up to 13 cm. The housing designs are rugged and compact, ideal for use in harsh industrial environments.

Flexible System Integration

Users can choose between two operating modes that are designed for easy and complex applications. **Easy mode** enables simple plug-and-play commissioning with minimal programming. With **Expert mode**, Pepperl+Fuchs also offers a solution for high-performance data access via a handshake procedure.

The standardized IO-Link interface on the read/write heads enables flexible connectivity to most common bus systems and controls.



IO-Link 1.1

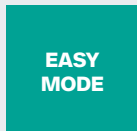
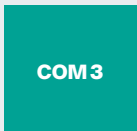

Selected products from the portfolio.
For more identification systems, visit
pepperl-fuchs.com/tf-io-ident



Highlights

- Easy mode reduces complexity without compromising performance
- System standardization with multiprotocol support for most common bus systems
- Flexible and efficient solution enables IO-Link read/write heads to be combined with other devices on Ethernet IO modules with IO-Link master

Technical Data

	IQT1-18GM-IO-V1	IQT1-F61-IO-V1	IQT1-FP-IO-V1
Operating frequency	13.56 MHz	13.56 MHz	13.56 MHz
Read/write distance	0 ... 50 mm	0 ... 55 mm	0 ... 130 mm
Electrical interface	IO-Link (V1.1)	IO-Link (V1.1)	IO-Link (V1.1)
Mechanical interface	M12 x 1	M12 x 1	M12 x 1
Conformity	According to ISO 15693		
Dimensions	ø 18 mm, length 63.5 mm	80 x 28 x 12 mm (L x W x H)	80 x 80 x 40 mm (L x W x H)

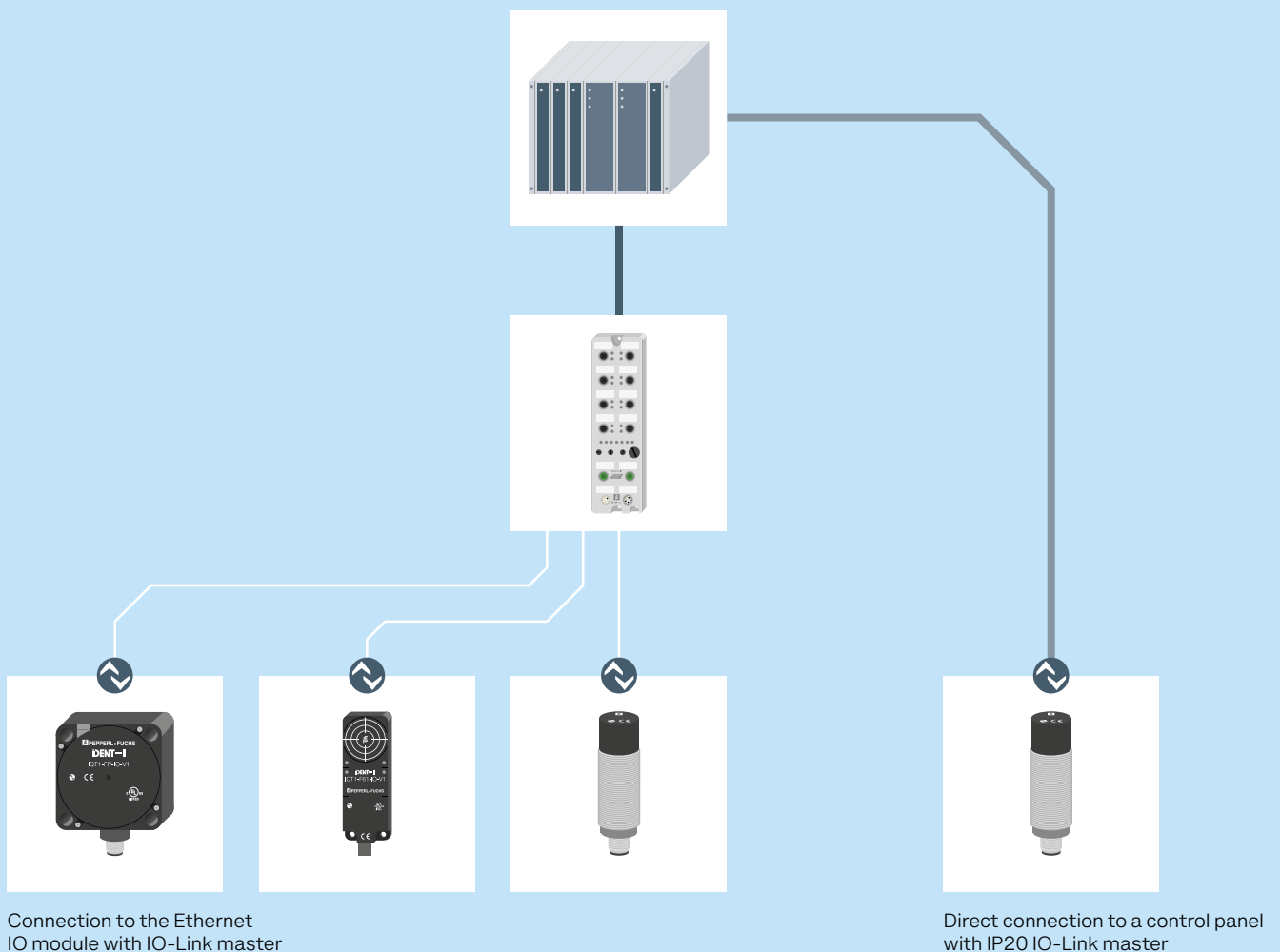

Efficient Integration of Binary Sensors and Actuators

Increased Efficiency with IO-Link

I/O hubs with IO-Link make it possible to easily and economically integrate digital sensors into the IO-Link communication channel. The hub has eight ports with digital inputs and outputs. Combined with an Ethernet IO module with integrated IO-Link master from Pepperl+Fuchs, signal transmission of up to 128 digital I/Os to higher-level control systems is enabled.

Since only one connector is necessary for signal transmission and power, wiring complexity is significantly reduced, leading to an especially efficient solution.

With a rugged housing design and extended temperature range of $-25\text{ }^{\circ}\text{C}$ to $+70\text{ }^{\circ}\text{C}$, the I/O hub can also be used in demanding industrial environments.



IO-Link 1.1



Up to IP69K



Up to 16 digital inputs/outputs

Selected products from the portfolio.

For more products, visit

pepperl-fuchs.com/tf-io-hub



Highlights

- Easy integration of binary sensors and actuators into automation systems via IO-Link
- Efficient signal transmission of up to 128 digital IOs via Pepperl+Fuchs' IO-Link master module to the control level
- Simpler cabling with one connection line for power and data transfer from the I/O hub to an IO-Link master

Technical Data	ICA-16DI-G60A-IO	ICA-10DI6DO-G60A-IO	ICA-16DIO-G60AL-IO
Inputs/outputs	16 digital inputs	10 digital inputs, 6 digital outputs	16 digital inputs/outputs, freely configurable
Shock/vibration	15 g/500 Hz		
Connections	Power supply and Inputs M12, A-coded		
Dimensions	160 mm x 60 mm x 31 mm (L x W x H)		

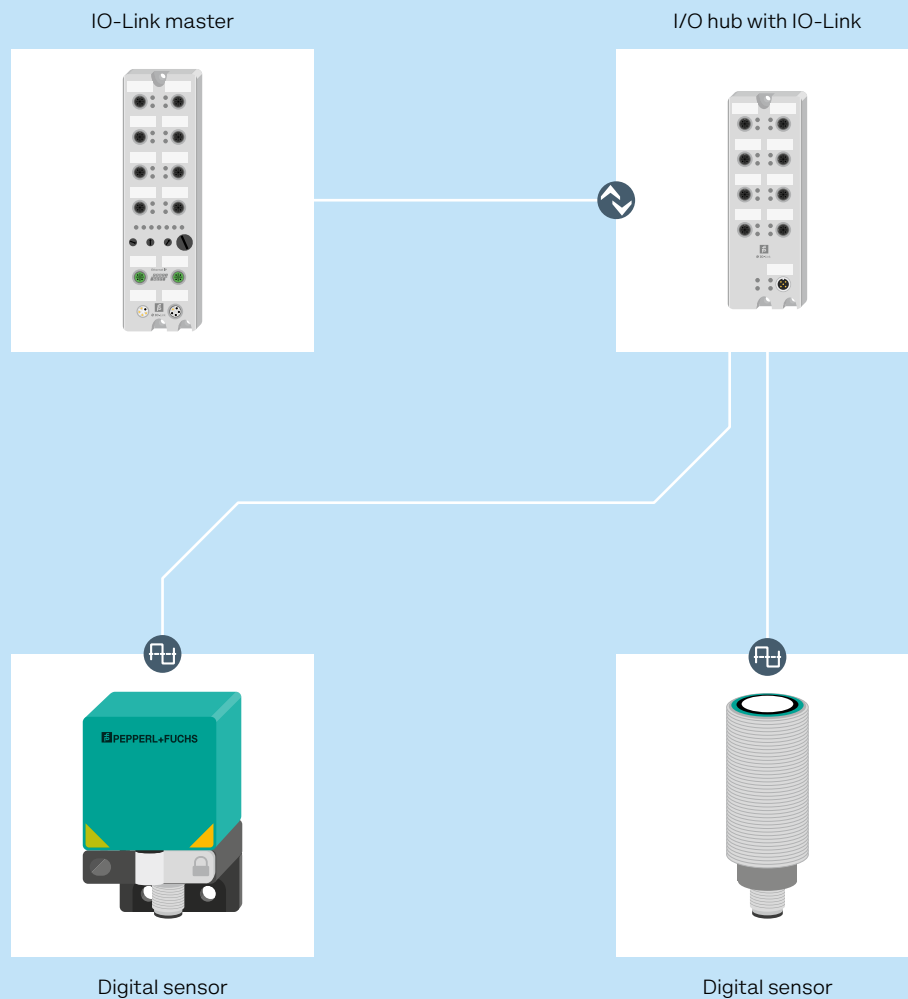

The Perfect Complement: Connection Technology and Accessories



High-performance sensors need strong connections to match. The comprehensive accessory portfolio from Pepperl+Fuchs delivers everything you need for optimal sensor connectivity.

Connection Technology from Pepperl+Fuchs

- **Sensor-actuator cables**—Countless globally certified cables and connectors for the perfect application solution
- **Field-attachable connectors**—A wide assortment of connectors suitable for a diverse range of applications
- **Junction blocks**—M8 and M12 multiport sensor connection blocks with master cable or connector for reduced installation costs
- **Sensor-actuator splitters**—Allow easy merging of two signals in one junction block port
- **Receptacles**—Signal routing from the control cabinet directly into the field
- **Data connectors**—Enable you to establish a reliable network between the different components of your automation system

The Right Cable for Every Situation

Each installation environment has its own set of requirements. The mechanical and chemical properties of the connection technology are crucial in determining the best solution. Pepperl+Fuchs offers the right cable for every situation.

- PVC—Solid and economical
- PUR—Durable and highly flexible
- PUR-U—Highly flexible with UL approval
- PUR-A—Resistant to weld sparks for the automotive industry
- PUR-O—Rugged for harsh outdoor applications
- PUR-R—Highly flexible for challenging robotics applications
- STOOW—Used widely in the American market
- POC—Weld-bead resistant



For more information, visit
[pepperl-fuchs.com/pf-connectivity](https://www.pepperl-fuchs.com/pf-connectivity)



Neoception Digital Services

Think digital, add value

An industrial plant automatically notifies its manufacturer when it reaches a certain number of operating hours. The need for wear parts is recognized, and the operator automatically receives a corresponding delivery. This additional service increases plant availability and makes maintenance and service processes more efficient. Well-designed, end-to-end digitalization generates added value for both manufacturers and operators.

Neoception GmbH is your partner on the path to value-added digitalization. We support you—as manufacturer or operator—in your pursuit of Industry 4.0, whether for the connection your products and plants to central data services or the data-driven optimization of your internal production and logistics processes.

- Have you always wanted to learn more about your products in the field to better serve your customers?
- Are you looking for digital innovations for your logistics or production?
- Are you convinced that the Internet of Things can prepare your company for the future but don't know where to start?

Then take the first step toward the digital future of your products. Contact us to learn how easy and intuitive access to Industry 4.0 can be.

In addition to individual consulting and flexible engineering services with core competences in the field of digitalization, we also take over the realization, operation, and maintenance of all necessary software components. Our focus is always on you, your benefits, and the benefits of your customers.

We rely on a broad network of partners from OT and IT companies to implement your applications. This cross-functional know-how enables you to find optimal solutions, implement lean applications, and immediately create real added value.

True to the motto “Think digital, add value,” we are your partner of choice for digital value-added services within in the Pepperl+Fuchs Group and beyond.



Your automation, our passion.

Explosion Protection

- Intrinsic Safety Barriers
- Signal Conditioners
- FieldConnex® Fieldbus Infrastructure
- Remote I/O Systems
- Electrical Explosion Protection Equipment
- Purge and Pressurization Systems
- HMI Systems
- Mobile Computing and Communications
- HART Interface Solutions
- Surge Protection
- Wireless Solutions
- Level Measurement

Industrial Sensors

- Proximity Sensors
- Photoelectric Sensors
- Industrial Vision
- Ultrasonic Sensors
- Rotary Encoders
- Positioning Systems
- Inclination and Acceleration Sensors
- Industrial Ethernet
- AS-Interface
- IO-Link
- Identification Systems
- Displays and Signal Processing
- Connectivity

www.pepperl-fuchs.com

Subject to modifications • © Pepperl+Fuchs
Printed in Germany • Part. No. 201648 10/20 07 • public



Pepperl+Fuchs Quality

Download our latest policy here:

www.pepperl-fuchs.com/quality